

NOVA 

EXOCLAD[®] QUICKCLIP[®]

 *Installation Guide*

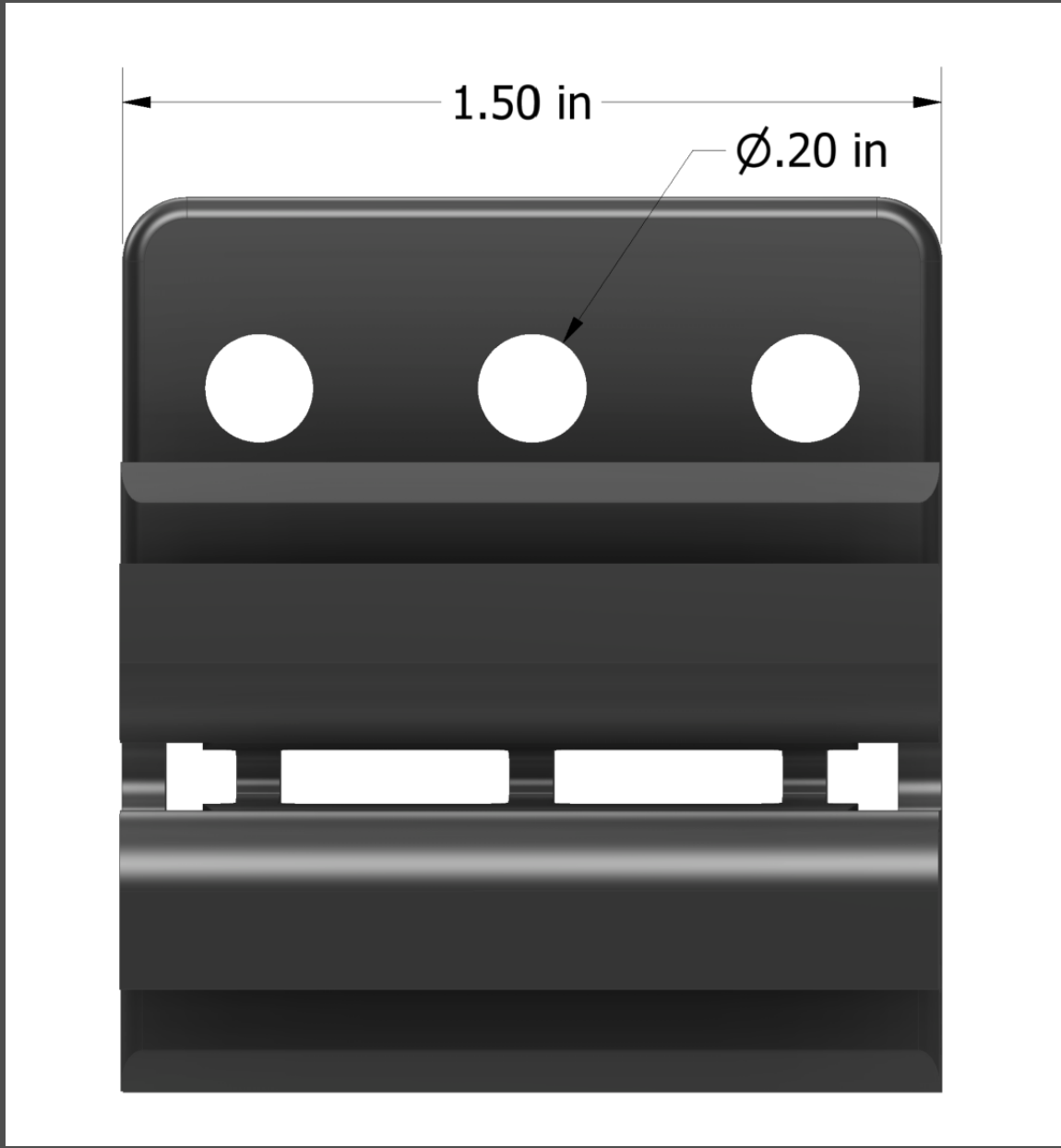
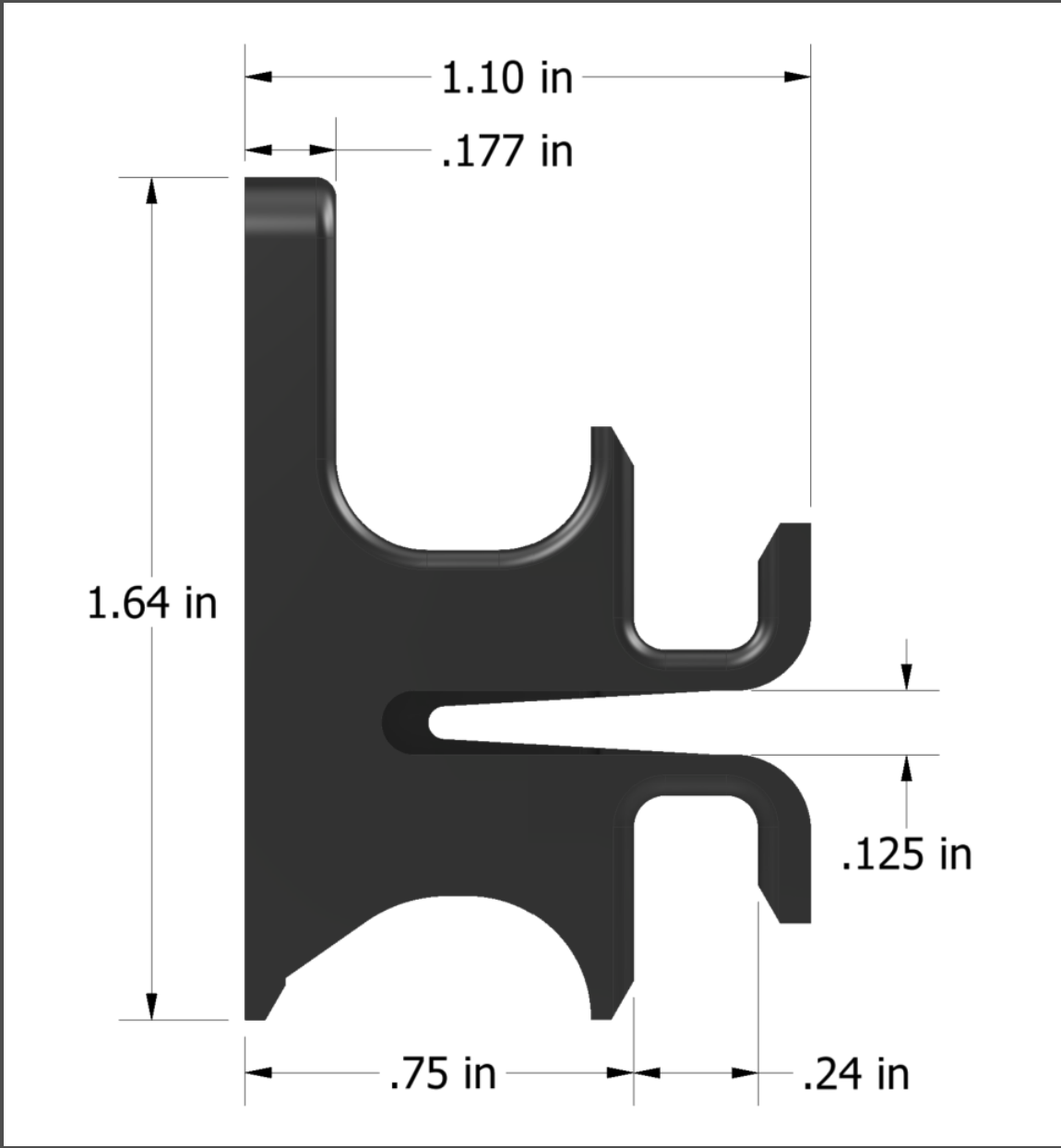

Materials

What comes in your **bucket**?

- **300** ExoClad[®] QuickClips[®]
 - Covers **100 SF** of siding with 1x6 rainscreen boards.

Custom quantities of any amount are also available for purchase!

Other tools and materials needed:

- Cor-A-Vent Siding Vent (3" or 4" wide)
- GRK R4 screw #9x2" or longer
- Cordless drill
- End seal
- Weather Resistive Barrier- House Wrap- Tyvek Equivalent
- Level
- Angle grinder
- Rubber mallet
- Chalk line
- ExoShield[®] Wood Stain
- Furring strips (just a few for finishing purposes)

IMPORTANT

FOR HARDWOOD SIDING INSTALLATION:

- Ensure that wood siding has properly acclimated to the environment and is at an appropriate moisture content
- Any freshly cut siding board ends must be sealed prior to installation
- If unfinished, pre-finish all 4 sides of siding boards with ExoShield[®] Wood Stain

Getting Started

- Proper Preparation and Alignment
 - *Steps 1-3*
- Creating and Securing Starter Clips
 - *Steps 4-5*
- Placing Cor-A-Vent
 - *Step 6*

Step 1: Install house wrap over Plywood sheathing to prevent moisture intrusion. (Always follow the vapor barrier manufacturer's instructions.)

Step 2: Using a chalk line, mark a level horizontal line at the point where the base of the Rainscreen siding will align. This is your baseline. It is recommended your first board sits a minimum of 6" above the ground.

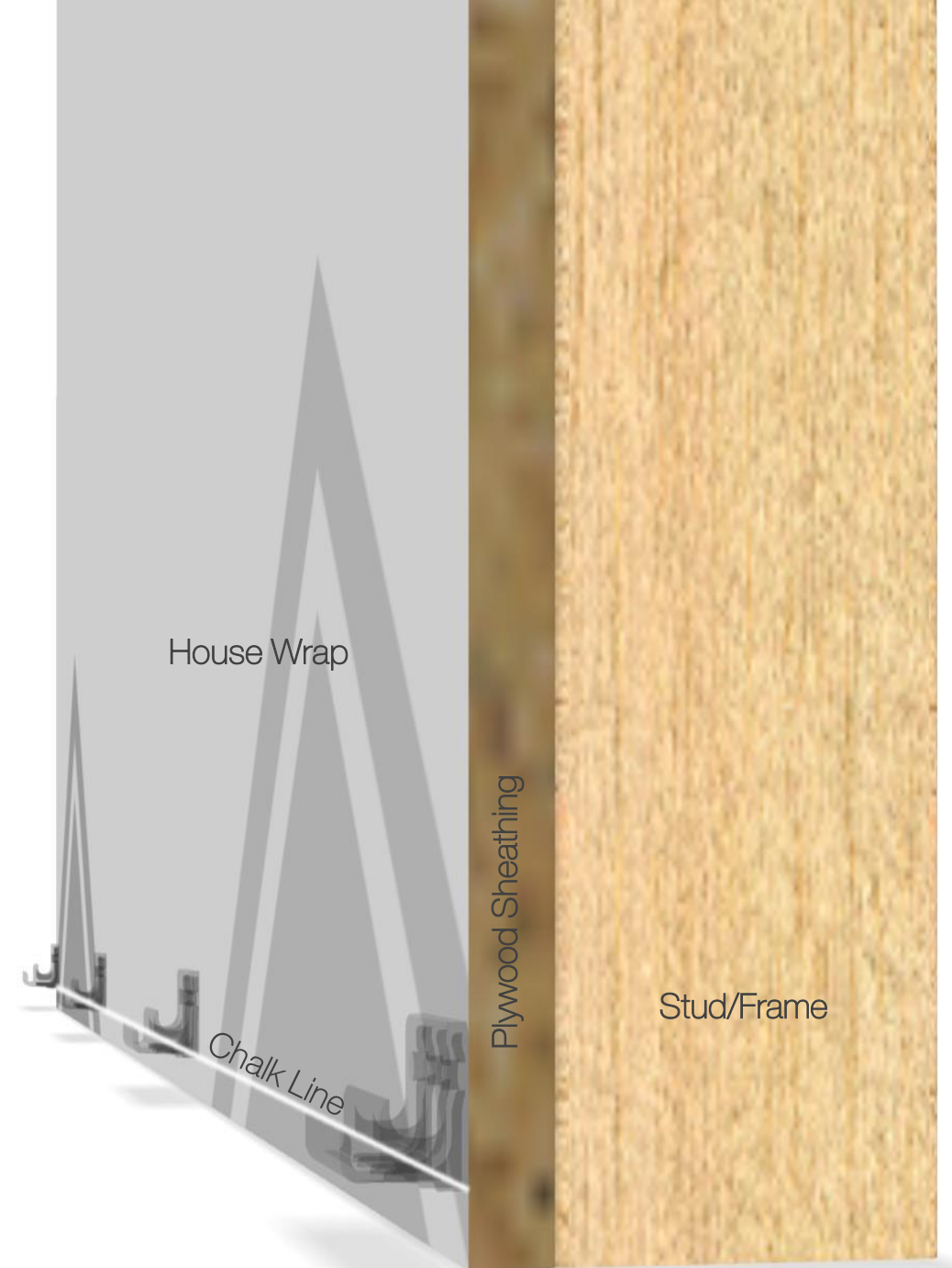

Step 3: Using a chalk line, mark where your studs are located for ease of installation.

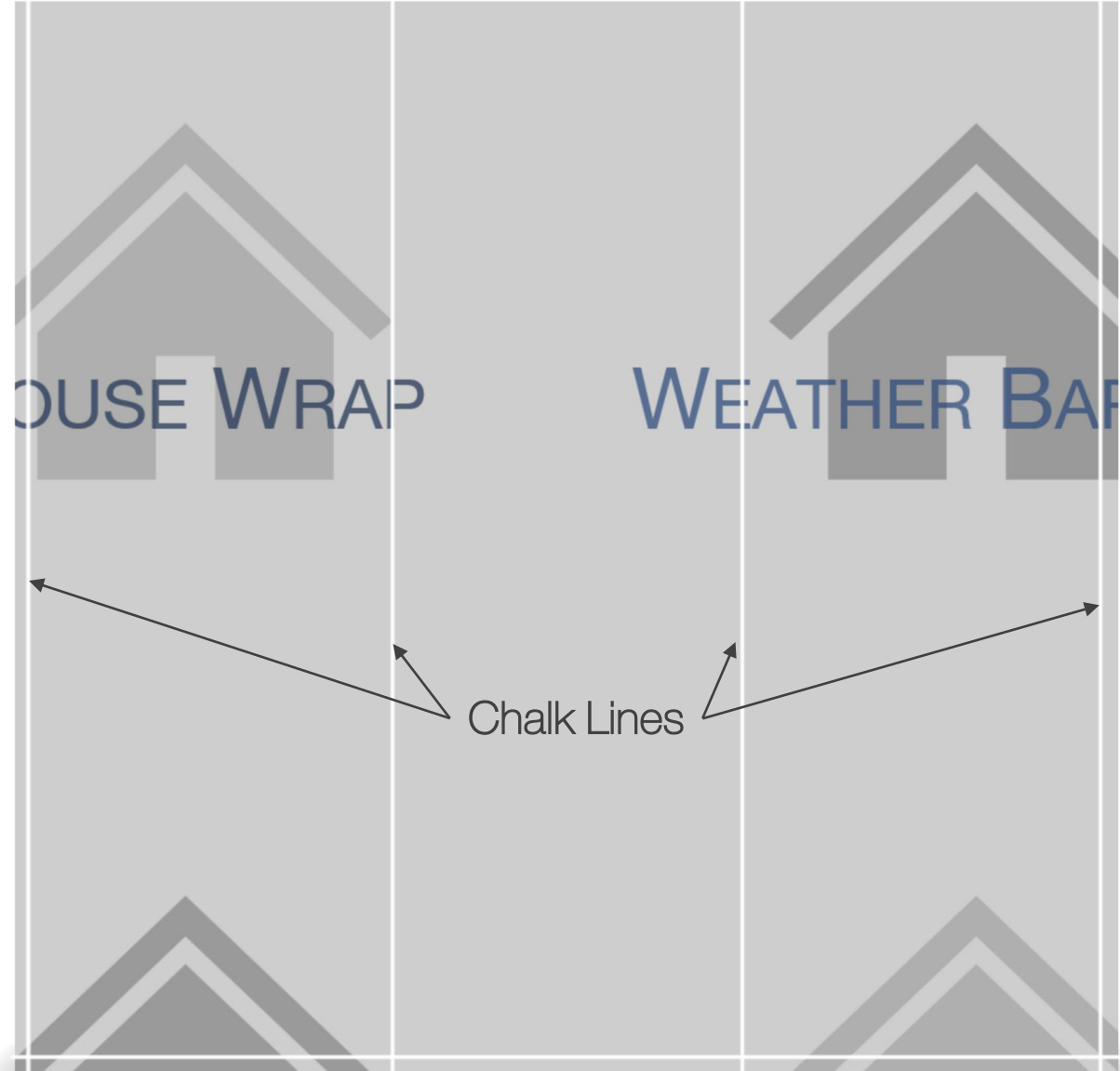
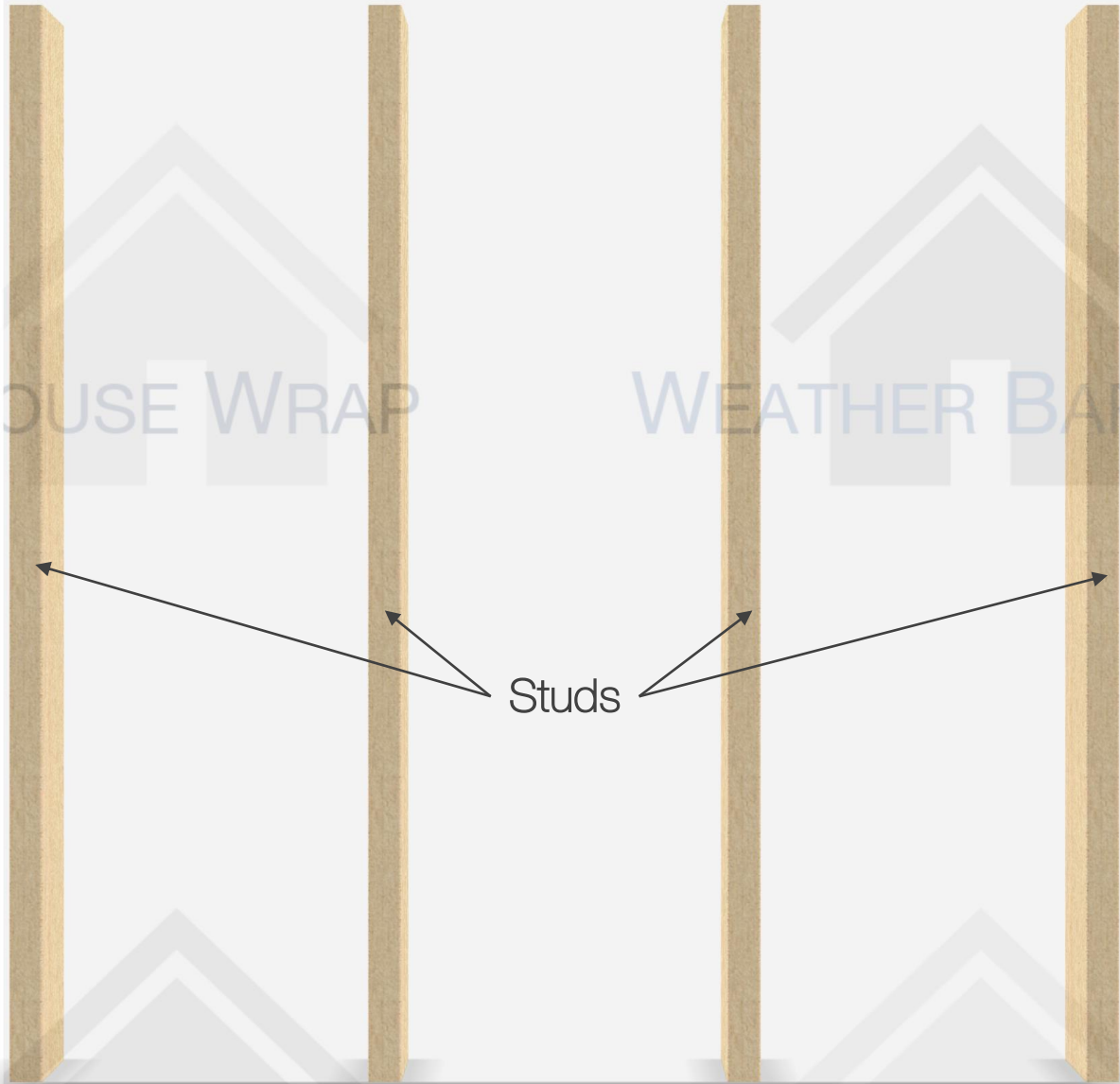

Step 4: Install your first series of clips on your baseline, screwing through the Vapor Barrier to the stud.

You may wish to cut the clip (an angle grinder will work) to eliminate the bottom part which will not be supporting anything).

Step 5: Align each starter clip with the studs you marked. Make sure that the clips are level and evenly spaced on the studs. You may need 2 screws for each clip for the first course of clips.



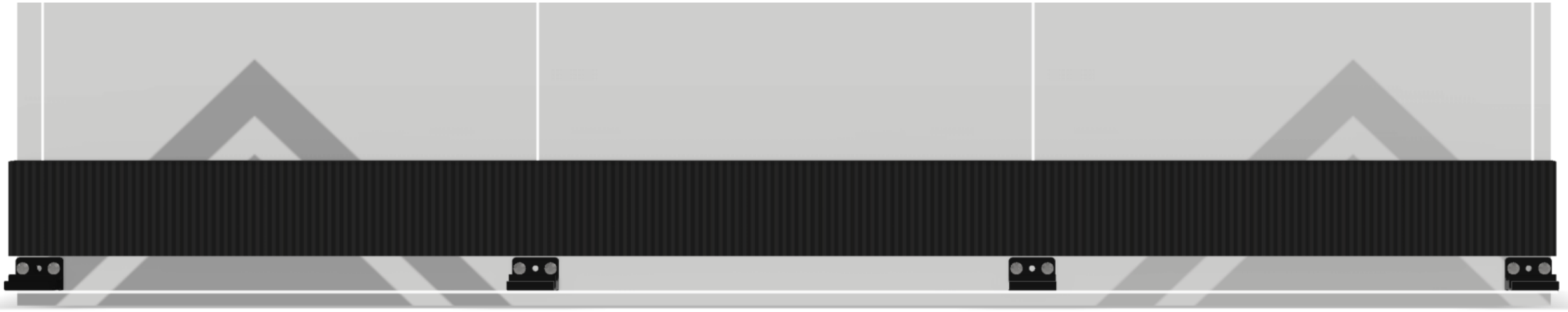

Step 6: Cut strips of Cor-A-Vent and screw into the vapor barrier/sheathing horizontally so that it fills the space between the clips. The Cor-A-Vent should run along the baseline behind your siding to permit airflow and to eliminate pests.



Filling in the Rest of Rainscreen Siding

- First Board
 - *Step 7*
- Filling In
 - *Steps 8-10*
- Properly Butting Two Boards Together
 - *Step 11*

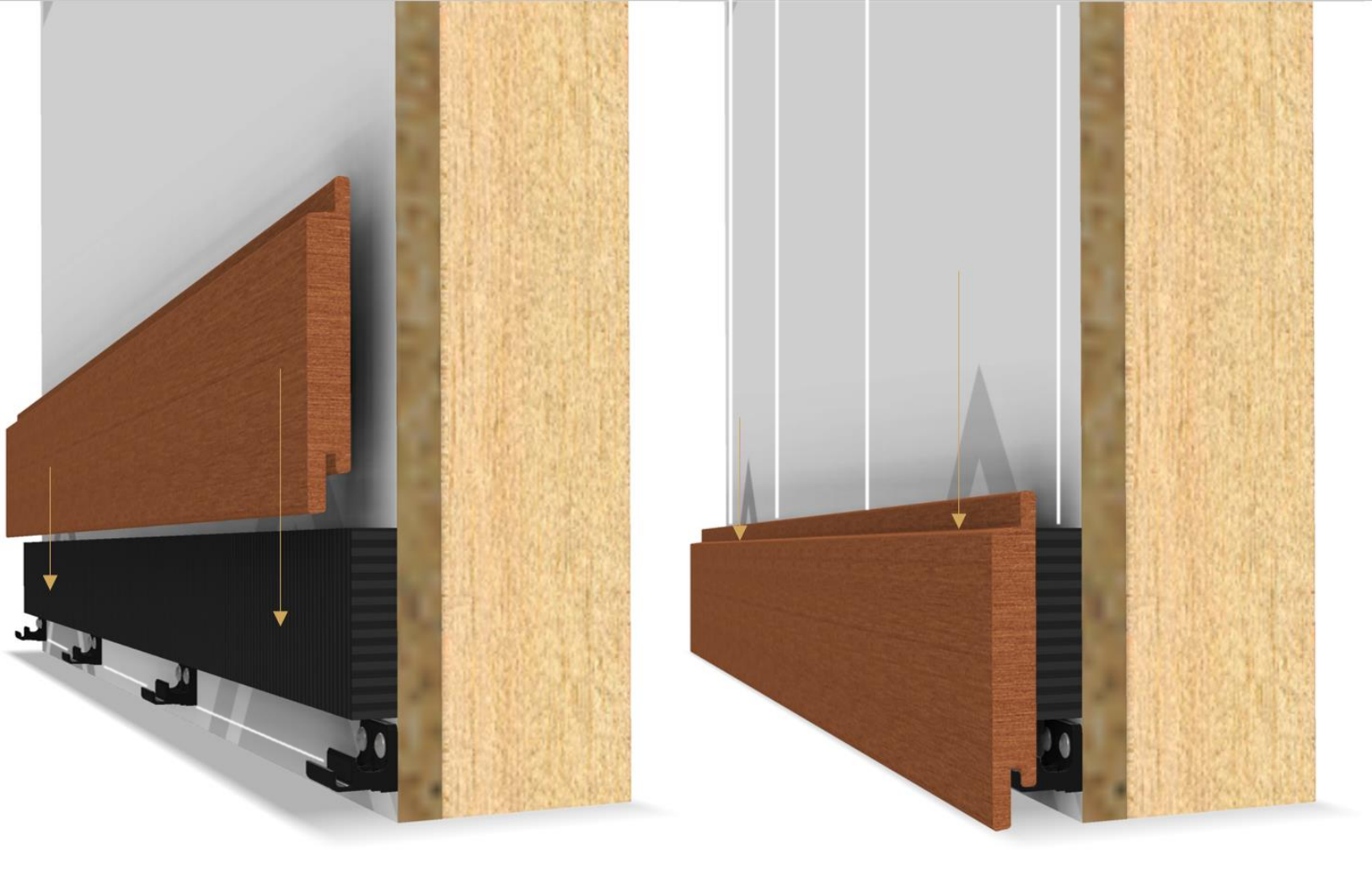

Step 7: Install the first Nova Rainscreen Siding board on top of the starter clips.

TIP: Use a level to ensure this first board is aligned properly.

Step 8: Fit the next course of clips over the first row of Rainscreen siding boards. Ensure that the edges are engaged – use a rubber mallet **CAREFULLY** to align boards properly.

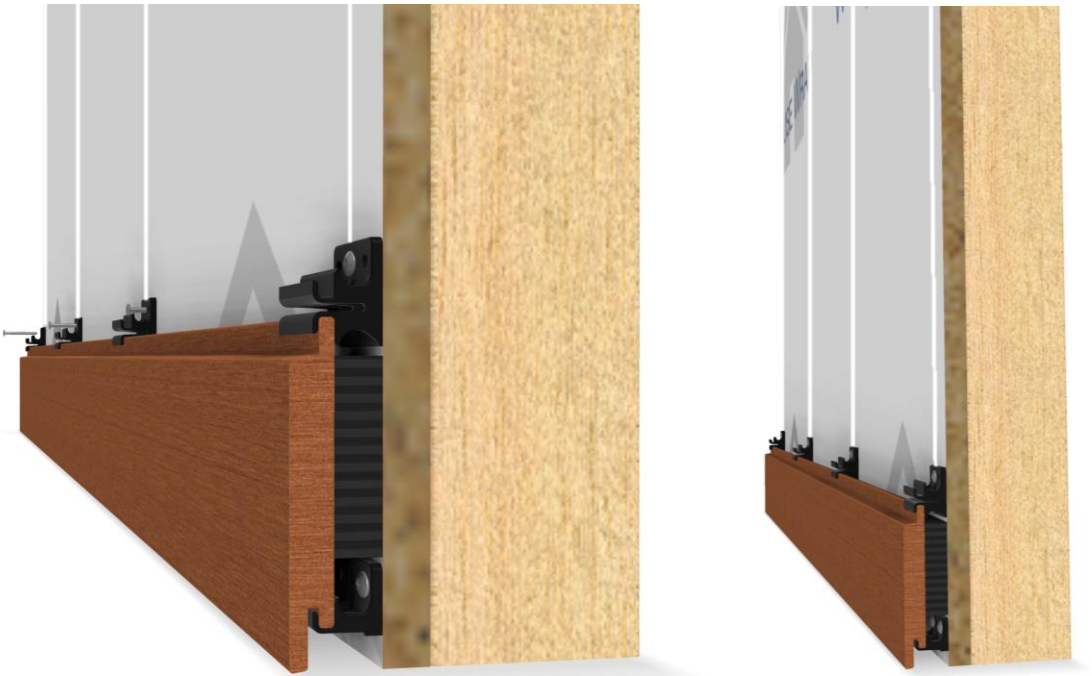

Step 9: Once the clips are engaged, install the second set of clips, driving one or two screws through the siding fastener into the stud. Ensure that the clips are level, and continue to check level throughout the installation.

Step 10: Set the proceeding Rainscreen siding boards on top of the installed siding fasteners. Continue to install clips and Rainscreen boards until you have reached the top of your installation area. Clips will usually require only one screw at this point of installation.

Step 11: When using multiple boards to span the length of the wall, ensure that the rainscreen boards butt together properly. The boards should meet in the middle of the stud, with a single clip centered between the two boards.

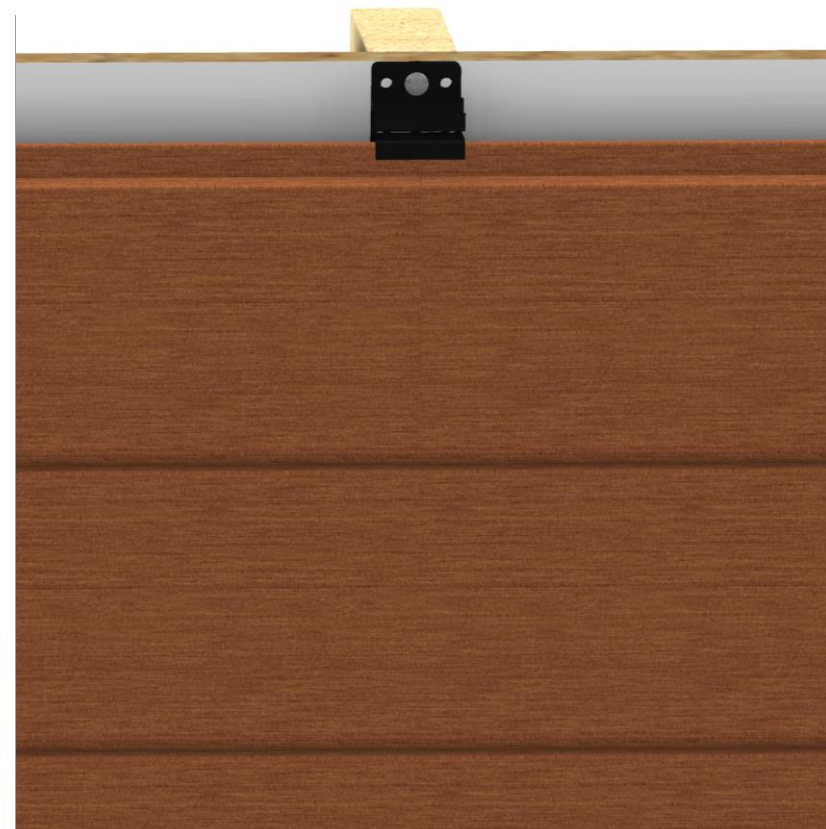
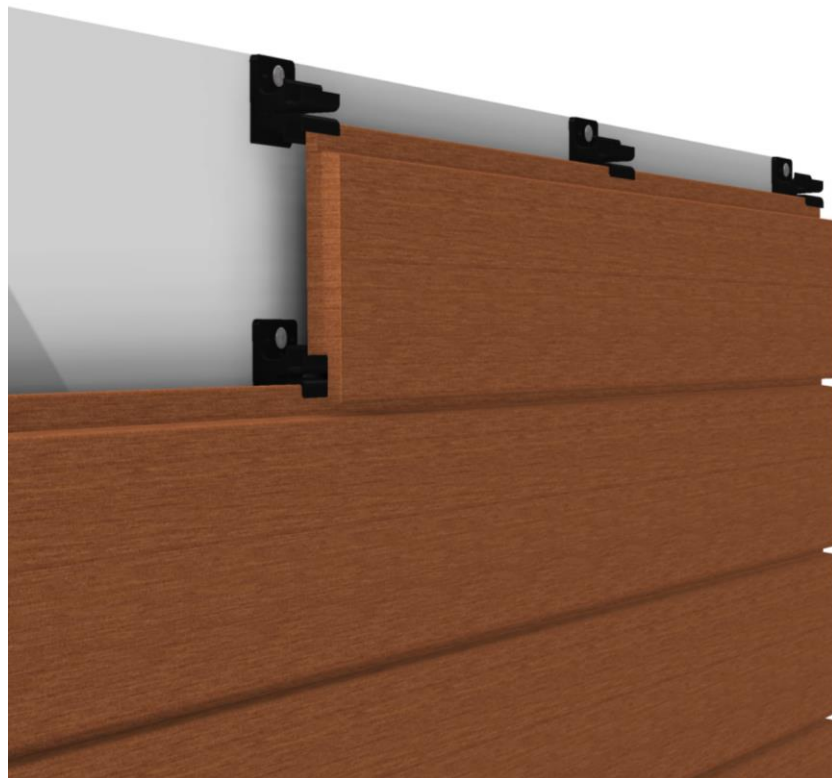
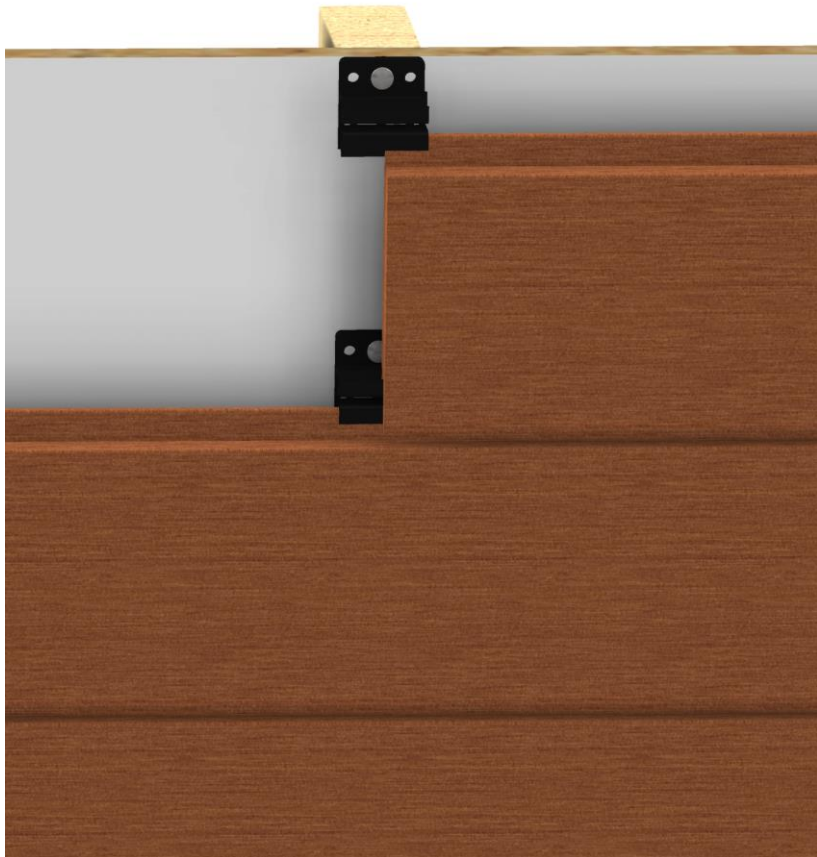

Finishing Up

- Placing Cor-A-Vent
 - *Step 12*
- Securing & Fitting Your Last Board
 - *Steps 13-15*

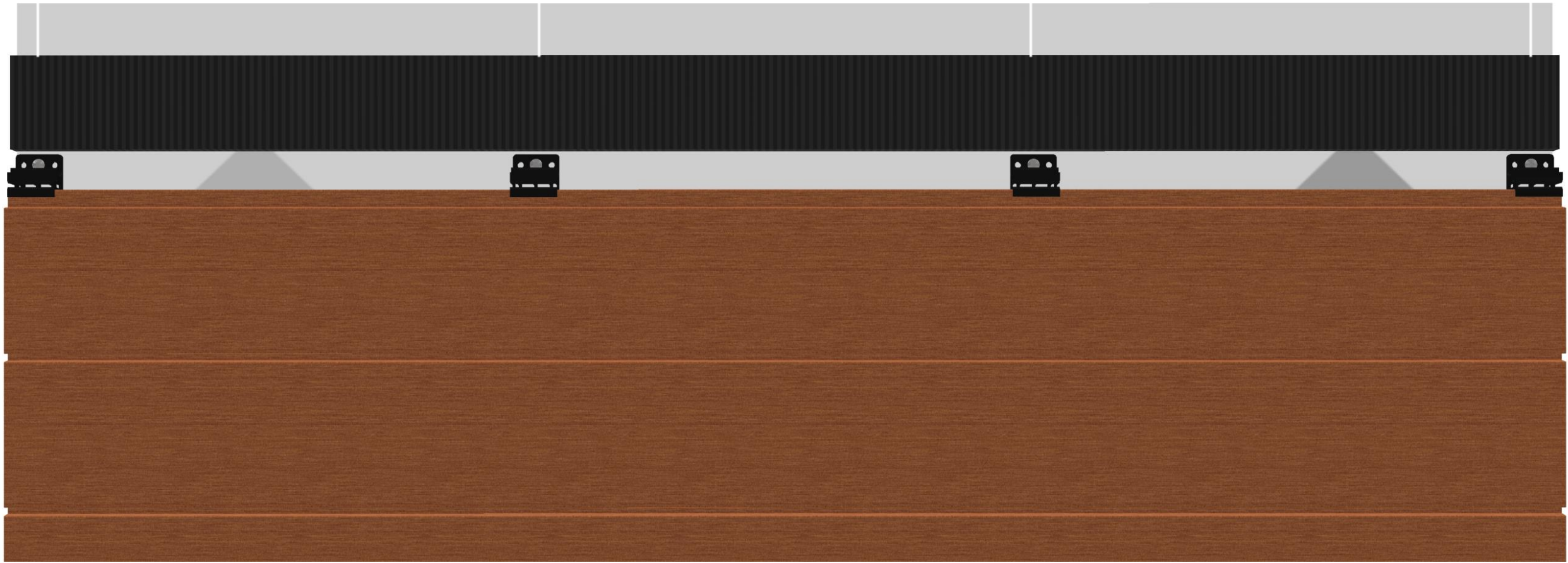

Step 12: When you are ready to install your last complete board, screw another course of Cor-A-Vent behind the board. The Cor-A-Vent will sit between your last two rows of clips.

Step 13: To install your final board, first measure the remaining span that needs covered. Trim (rip) your rainscreen board to the appropriate width. Make sure you are trimming the correct side of the board off and leaving the correct side intact to fit into the clips.

Step 14: Fasten a 1 x 2 furring strip across the length of the wall through the particle board and into the framing.

Step 15: Insert the adjusted board into the last row of clips. Fasten the rainscreen board to the furring strips.



Step 13: (Optional) Create a beautiful finish by installing trim pieces of the same material as your rainscreen boards along your corners and edges.

Step 14: Complete your siding install by finishing with a high quality oil-based finish of your choice. Nova offers our own finish, ExoShield[®]. Recommended maintenance cycle is once every 3 to 5 years for longest lasting color, UV protection and moisture protection!

For complete instructions on how to properly apply ExoShield[®], please visit:
<https://www.novausawood.com/exoshield>



IMPORTANT

You must contact your local building department before you begin designing your project. Your local building department (and/or Homeowner Association) will inform you of any zoning ordinances and buildings codes that specify where and how you can build. You are responsible for applying for and obtaining any and all required permits for your project.

Disclaimer:

Nova USA Wood Products provides this information as possible suggestions only and will not be held liable for your project's suitability or should you choose not to obtain the required permits, or if you fail to comply with all zoning ordinances and building codes.

By purchasing material from Nova USA Wood Products, you agree to comply with our Terms & Conditions. Our siding products are carefully manufactured and inspected to ensure quality. However, these are natural wood products and are subject to variations in weight, density, color, grain and performance. Wood siding is naturally subject to dimensional changes as the moisture content in the wood fluctuates with humidity in the air. Swelling, shrinkage, checking and other movement of individual pieces are normal occurrences in wood siding.

If you have any questions, contact us for written clarification prior to starting your project

Any Questions?



Please visit our FAQ page at

help.novausawood.com/Topic/ExoClad-QuickClips/4768120



Or call

(503) 419-6407

Vertical Installation

A. Horizontal Trim Board Method: pg. 21 – 34

B. No Horizontal Trim Board Method: pg. 35 – 46



A.
*Horizontal Trim Board
Method*



Getting Started

- Proper Preparation and Alignment
 - *Steps 1-3*
- Creating and Securing Starter Clips
 - *Steps 4-5*
- Creating and Securing Trim Board
 - *Steps 6-10*

IMPORTANT! Ensure that your sheathing is rated for structural use and installed according the manufactures guidelines and local building codes. Structural sheathing is the only safe way to install vertical rainscreen without adding additional framing or use of furring strips.

Step 1: Install house wrap over Plywood sheathing to prevent moisture intrusion. (Always follow the vapor barrier manufacturer's instructions.)

Step 2: Using a chalk line, mark a level horizontal line at the point where the base of the Rainscreen siding will align. This is your baseline. It is recommended that your boards sit a minimum of 6" above the ground.

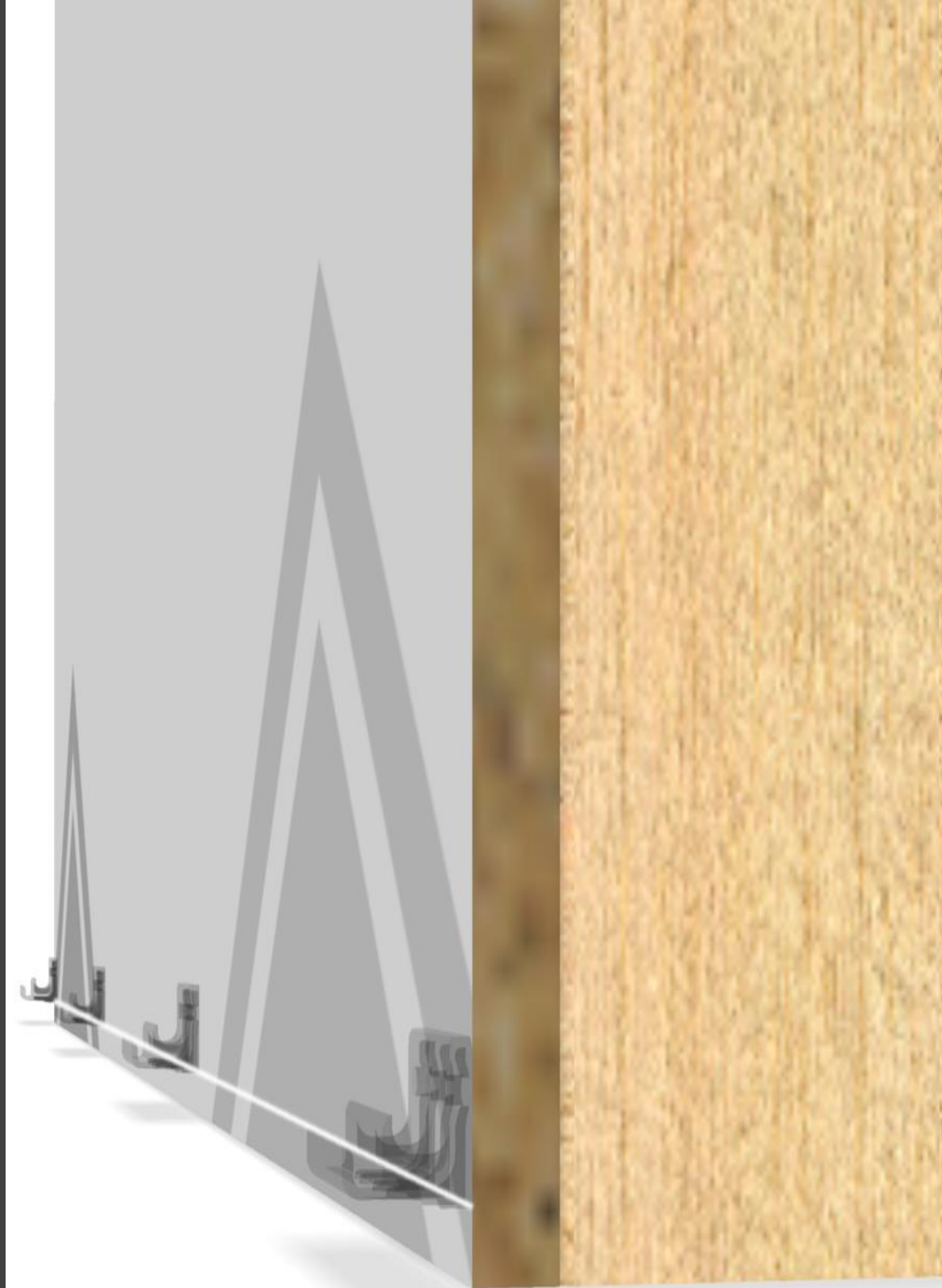

Step 3: Using a chalk line, mark where your studs are located for ease of installation.

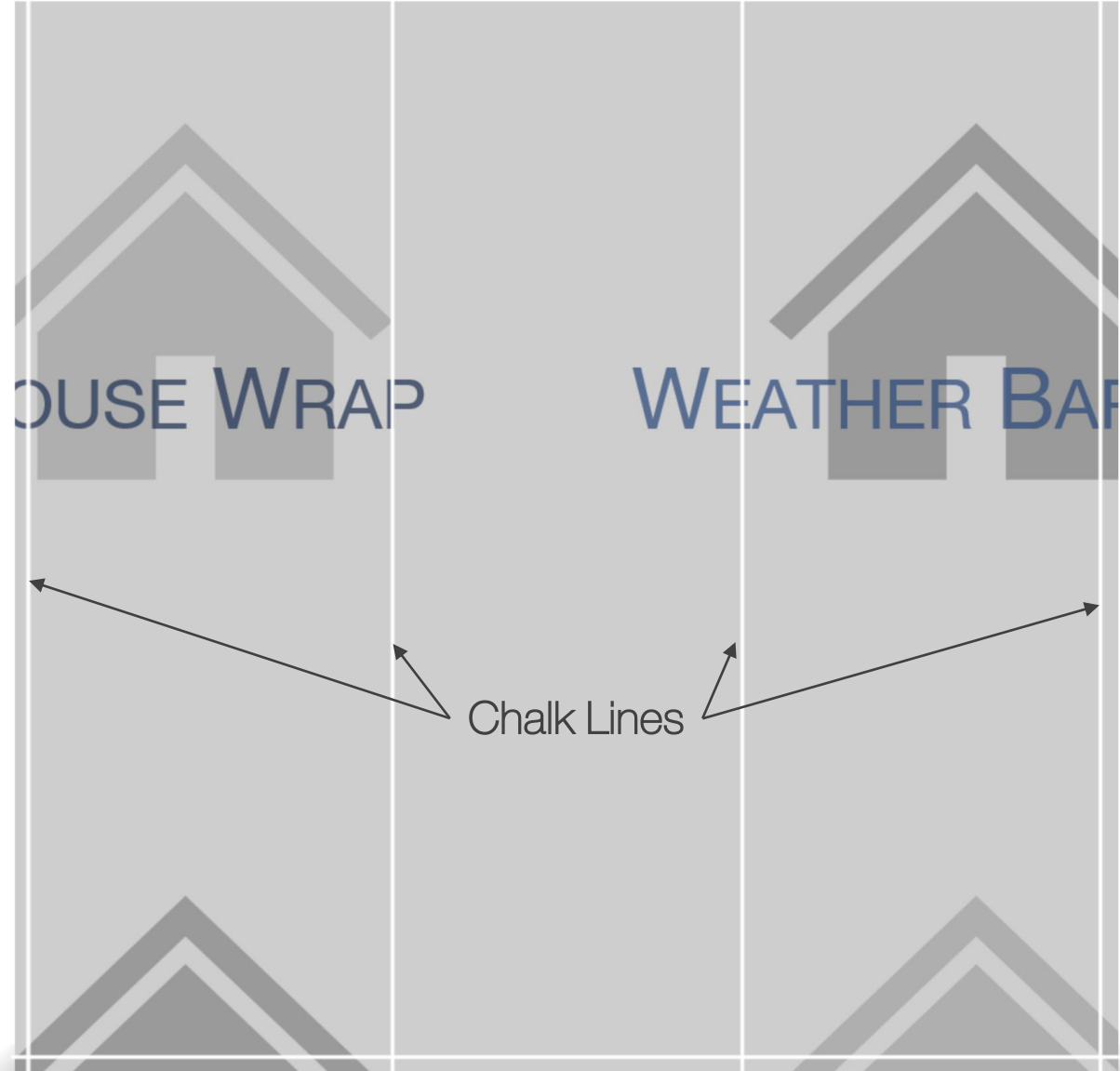
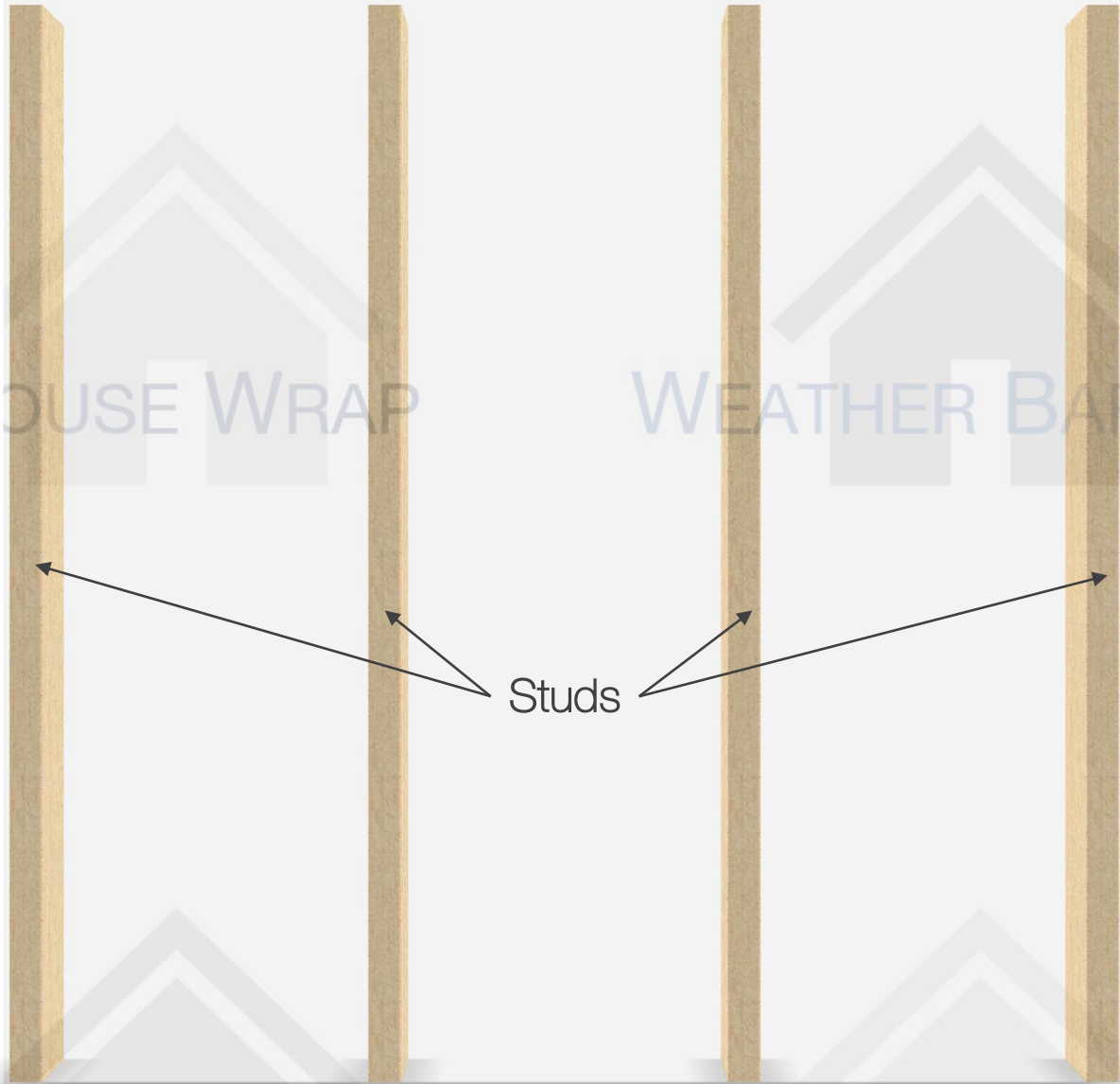

Step 4: Install your first series of clips on your baseline, screwing through the Vapor Barrier to the stud.

You may wish to cut the clip (an angle grinder will work) to eliminate the bottom part which will not be supporting anything).

Step 5: Align each starter clip with the studs you marked. Make sure that the clips are level and evenly spaced on the studs. You may need 2 screws for each clip for the first course of clips.



Discarded End

Cut



Step 6: Rip/trim the top groove off of however many rainscreen boards are needed to cover the length of the wall.

Step 7: Obtain enough length of 1 x 2" furring strips to cover the entire length of the wall. Cut small vertical channels (weep holes) into the furring strip approximately 12 inches apart. These are required to allow for drainage through the furring strip. These channels will face the wall.

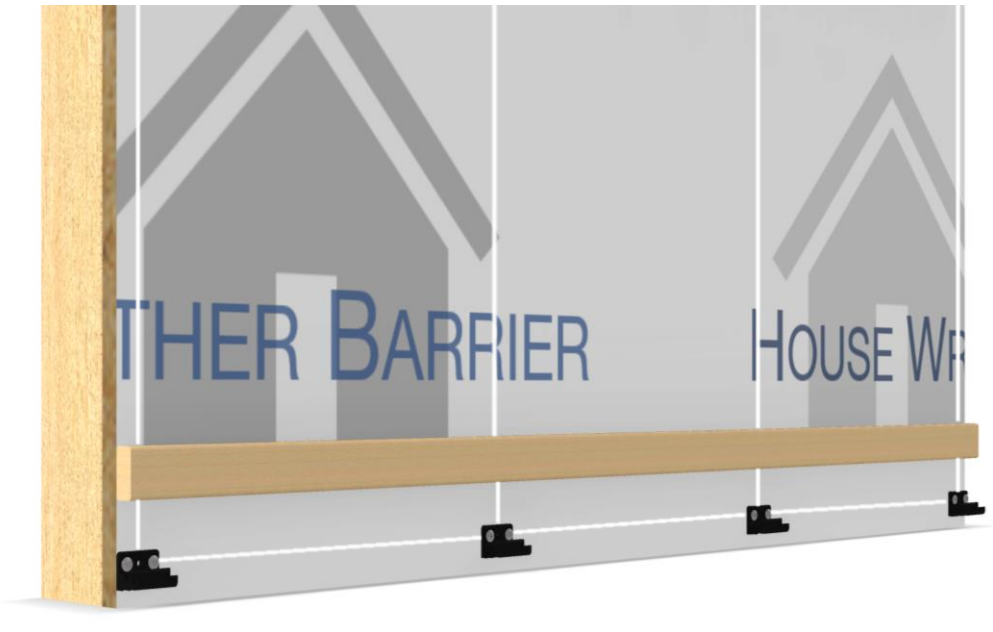
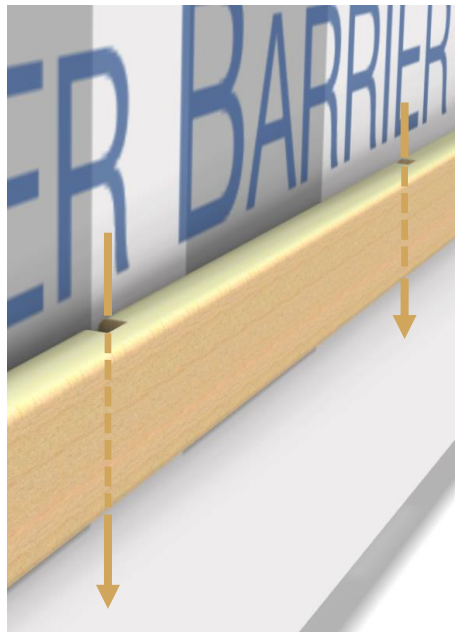

Step 8: Fasten the furring strip across the length of the wall above the installed starter clips to the appropriate height that matches the width of the trim board. Ensure the furring strip is installed into the framing

Step 9: Insert the trimmed rainscreen board into the row of starter clips. Gently tap board with rubber mallet if need to insert the board fully into the clips.

Step 10: Fasten the rainscreen board to the furring strips. You will need to pre-drill the rainscreen board in order to face screw and avoid any splitting. We recommend using a screw and plug system for a seamless look.



Filling in the Rest of Rainscreen Siding

- Marking Clip Placement and Installing Cor-A-Vent
 - *Steps 11-13*
- First Vertical Board
 - *Steps 14-15*
- Filling In
 - *Step 16*
- Properly Butting Two Boards Together
 - *Step 17*

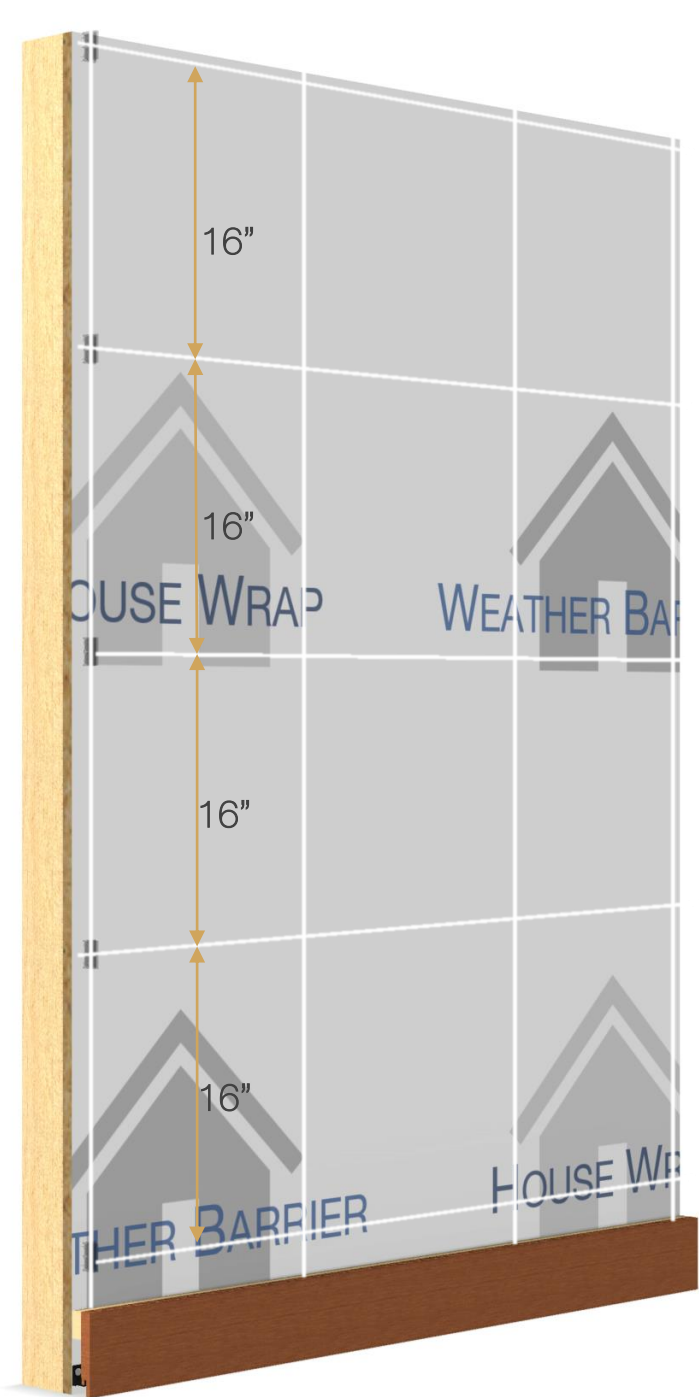

Step 11: Create horizontal chalk lines marking every 16 inches. These are the lines is where your clips will be placed.

Step 12: Fasten your first column of clips. Depending on the wall you are building on, you may wish to cut the clip like from **Step 4**, to eliminate the side of the clip that would be on the outside.

Step 13: Install Cor-A-Vent appropriately at the top and bottom of your wall across the entire width.



Step 14: Insert your first vertical board into the column of clips, gently tapping with rubber mallet if necessary.

TIP: Use a level to ensure this first board is aligned properly.



Step 15: Fasten your next column of clips using 1-2 screws on each clip and ensuring that they are lined up on your horizontal chalk lines.



Step 16: Continue to install clips and Rainscreen boards until you have covered the span of your installation area. Clips will usually require only one screw each at this point of installation.

Step 17: When using multiple boards to span the height of the wall, ensure that the rainscreen boards butt together properly. The boards should meet with a single clip centered between the two boards.

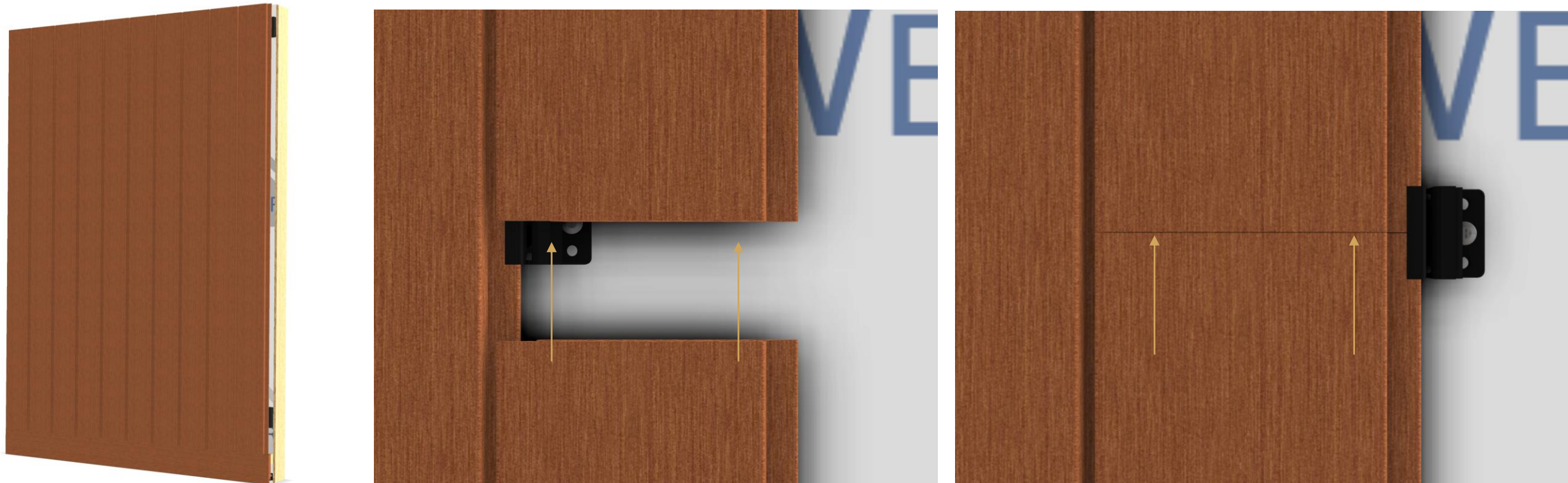

Finishing Up

- Securing & Fitting Your Last Board
 - *Steps 18-20*

Step 18: To install your final board, first measure the remaining span that needs covered. Trim (rip) your rainscreen board to the appropriate width. Make sure you are trimming the correct side of the board off and leaving the correct side intact to fit into the clips.

Step 19: Fasten a 1 x 2 furring strip up the height the length of the wall through the particle board and into the framing.

Step 20: Insert the adjusted board into the last column of clips. Fasten the rainscreen board to the furring strips.



Step 21: (Optional) Create a beautiful finish by installing trim pieces of the same material as your rainscreen boards along your corners and edges.

Step 22: Complete your siding install by finishing with a high quality oil-based finish of your choice. Nova offers our own finish, ExoShield[®]. Recommended maintenance cycle is once every 3 to 5 years for longest lasting color, UV protection and moisture protection!

For complete instructions on how to properly apply ExoShield[®], please visit:
<https://www.novausawood.com/exoshield>





B.
*No Horizontal Trim
Method*

Getting Started

- Proper Preparation and Alignment
 - *Steps 1-3*
- Securing Furring Strip Baseline
 - *Steps 4-5*

IMPORTANT! Ensure that your sheathing is rated for structural use and installed according the manufactures guidelines and local building codes. Structural sheathing is the only safe way to install vertical rainscreen without adding additional framing or use of furring strips.

Step 1: Install house wrap over Plywood sheathing to prevent moisture intrusion. (Always follow the vapor barrier manufacturer's instructions.)

Step 2: Using a chalk line, mark a level horizontal line at the point where the base of the Rainscreen siding will align. This is your baseline. It is recommended that your boards sit a minimum of 6" above the ground.



Step 3: Using a chalk line, mark where your studs are located for ease of installation.

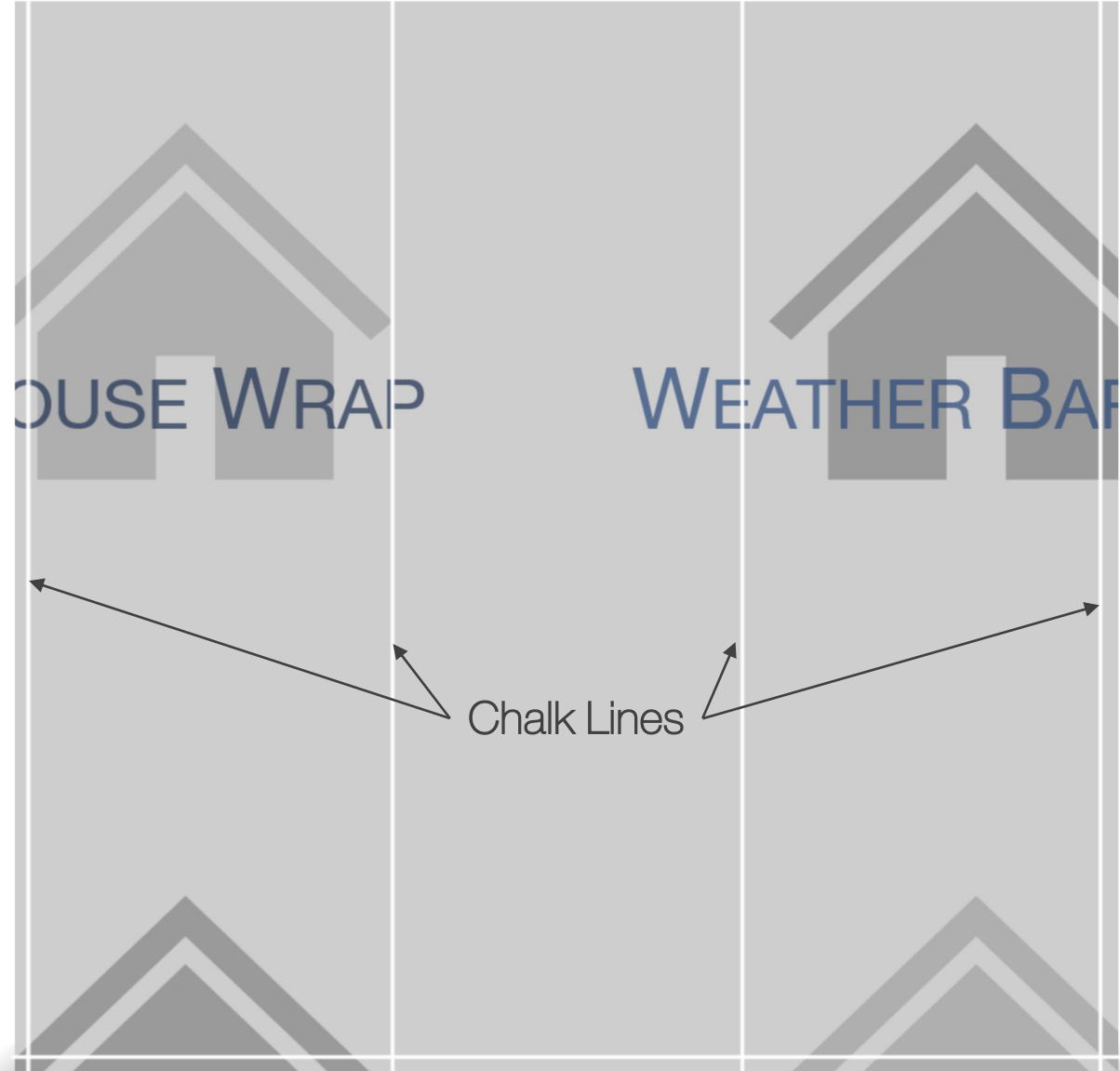
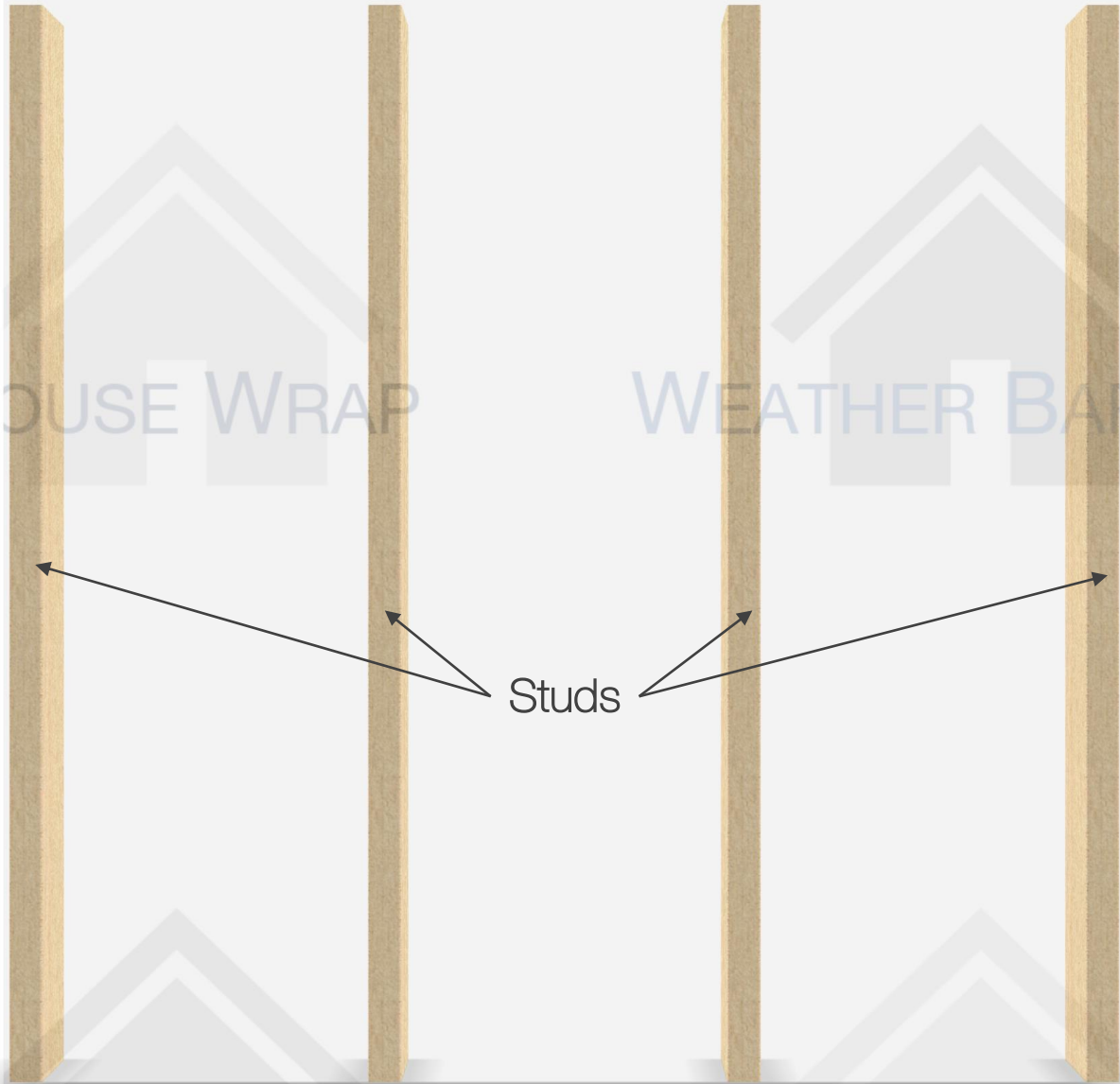

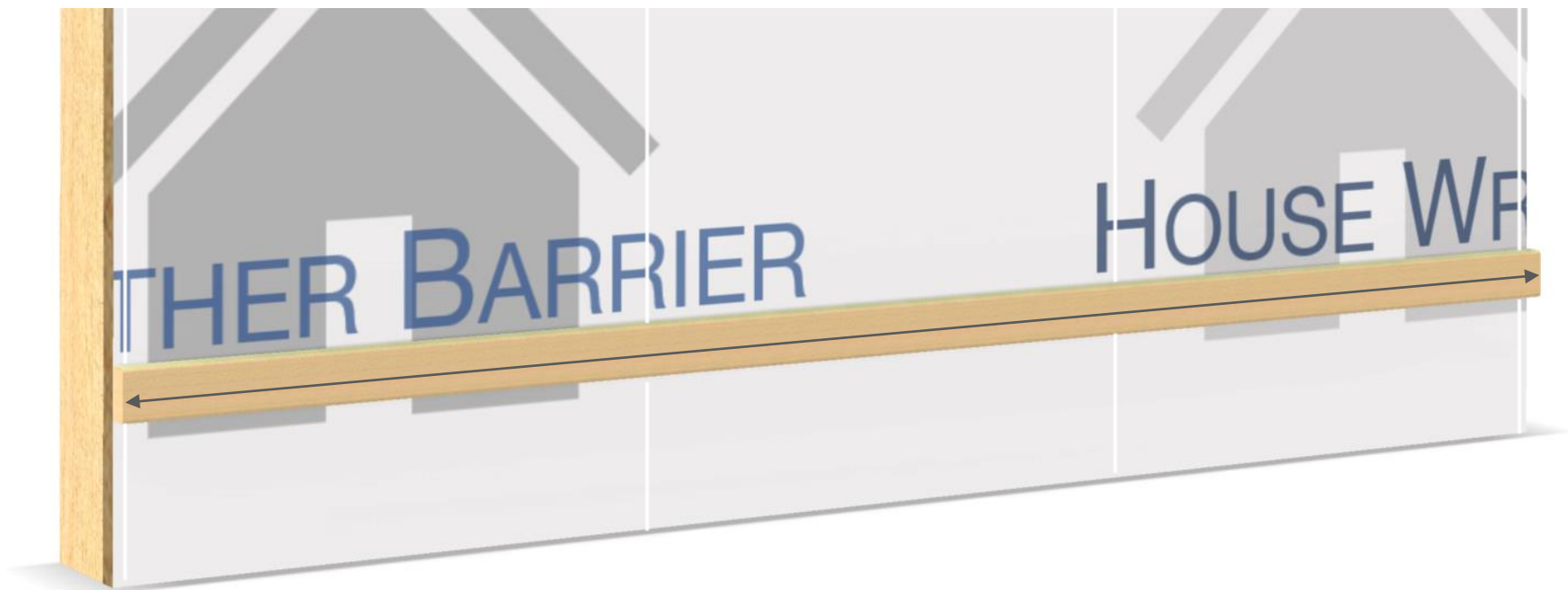

Step 4: Obtain enough length of 1 x 2" furring strips to cover the entire length of the wall. Cut small vertical channels (weep holes) into the furring strip approximately 12 inches apart. These are required to allow for drainage through the furring strip. These channels will face the wall.

Step 5: Fasten the furring strip across the length of the wall. Ensure the furring strip is installed into the framing. This furring strip will act as your baseline so use a level to ensure it is perfectly horizontal.

Filling in the Rest of Rainscreen Siding

- Marking Clip Placement and Installing Cor-A-Vent
 - *Steps 6-8*
- First Vertical Board
 - *Steps 9-10*
- Filling In
 - *Steps 11*
- Properly Butting Two Boards Together
 - *Step 12*

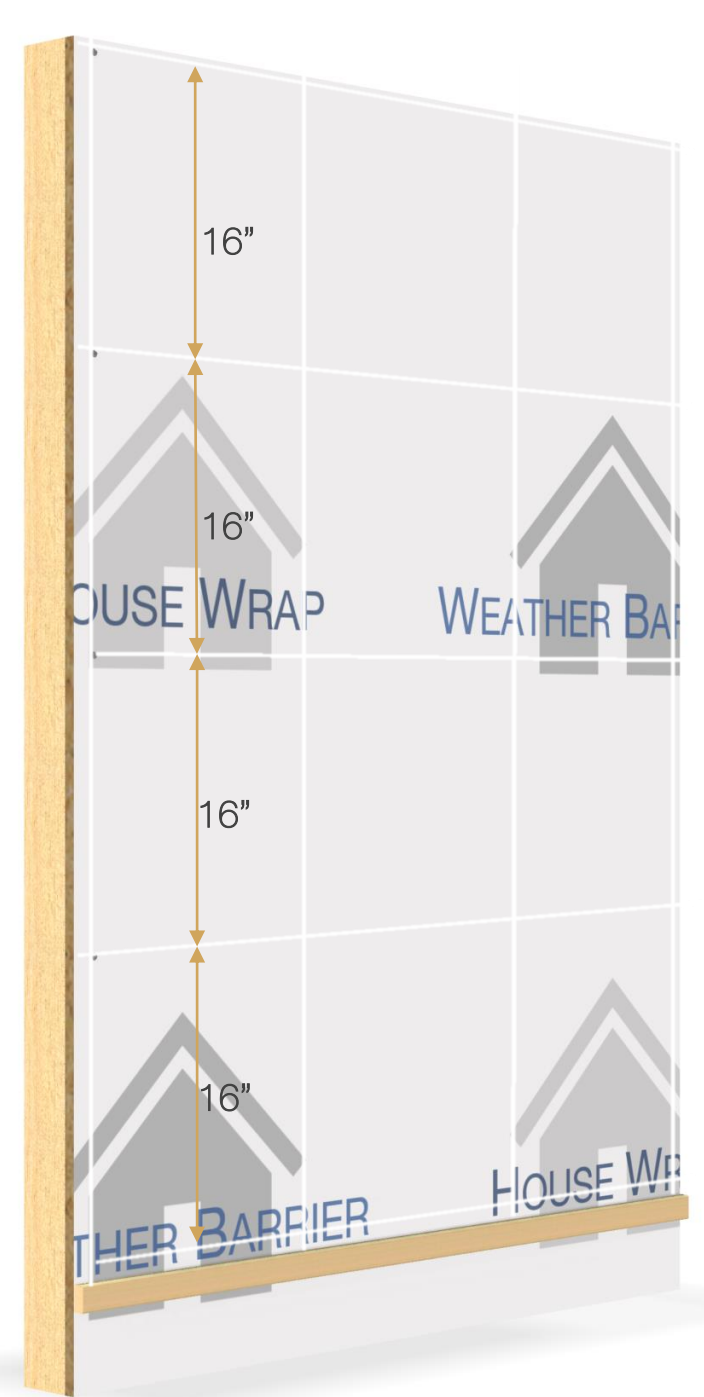

Step 6: Create horizontal chalk lines marking every 16 inches. These are the lines is where your clips will be placed.

Step 7: Fasten your first column of clips. Depending on the wall you are building on, you may wish to cut the clip like from *pg. 8*, to eliminate the side of the clip that would be on the outside.

Step 8: Install Cor-A-Vent appropriately at the top and bottom of your wall across the entire width.



Step 9: Insert your first vertical board into the column of clips, gently tapping with rubber mallet if necessary.

TIP: Use a level to ensure this first board is aligned properly.

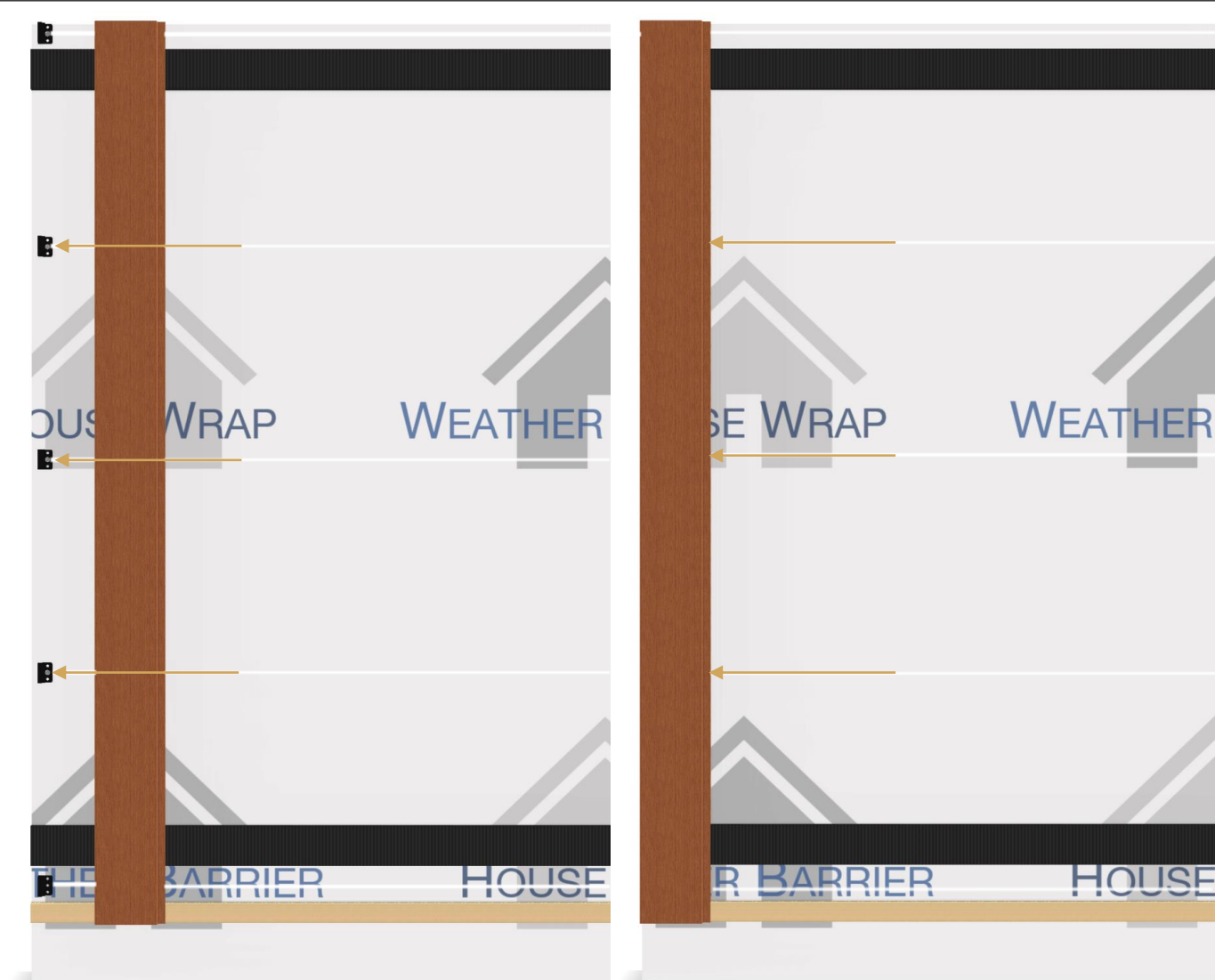

Step 10: Gently tap the bottom of the rainscreen board until it is flush with the furring strip. Fasten the board through the face with 2 screws. You will need to pre-drill the rainscreen board in order to face screw and avoid any splitting. We recommend using a screw and plug system for a seamless look.



Step 11: Continue to install clips and Rainscreen boards repeating *Steps 9 & 10* until you have covered the span of your installation area. Clips will usually require only one screw each at this point of installation.

Step 12: When using multiple boards to span the height of the wall, ensure that the rainscreen boards butt together properly. The boards should meet with a single clip centered between the two boards.

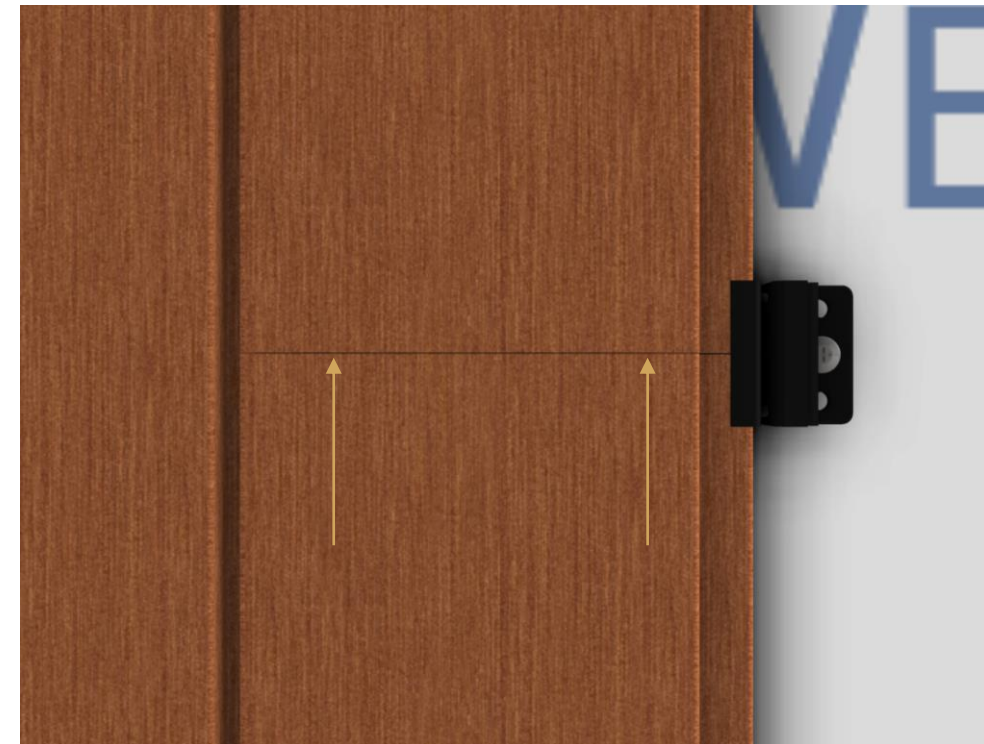
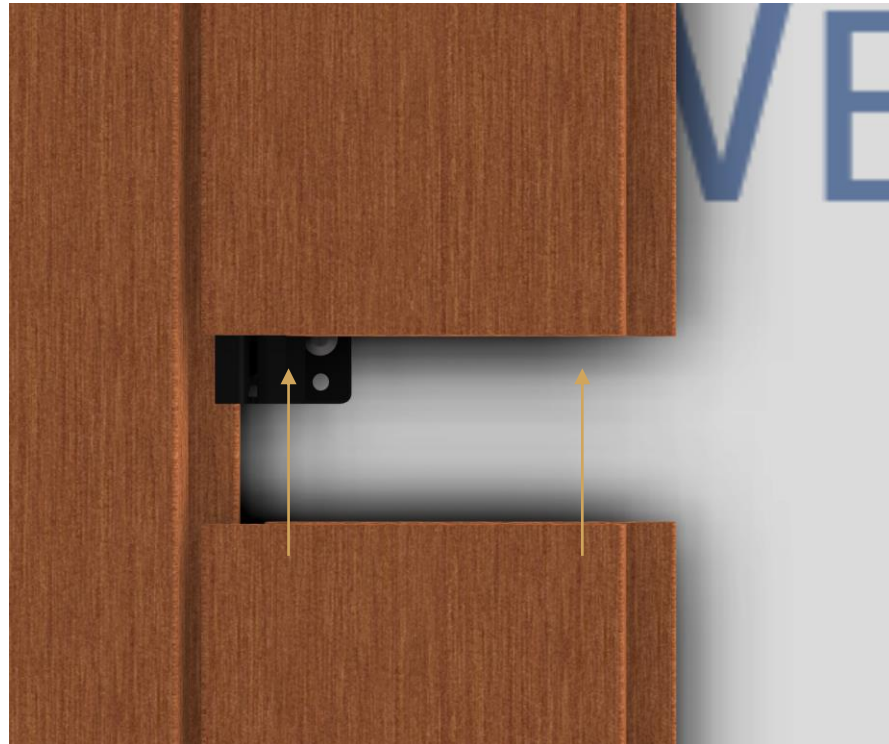

Finishing Up

- Securing & Fitting Your Last Board
 - *Steps 13-15*

Step 13: To install your final board, first measure the remaining span that needs covered. Trim (rip) your rainscreen board to the appropriate width. Make sure you are trimming the correct side of the board off and leaving the correct side intact to fit into the clips.

Step 14: Fasten a 1 x 2 furring strip up the height the length of the wall through the particle board and into the framing.

Step 15: Insert the adjusted board into the last column of clips. Fasten the rainscreen board to the furring strips.



Step 16: (Optional) Create a beautiful finish by installing trim pieces of the same material as your rainscreen boards along your corners and edges.

Step 17: Complete your siding install by finishing with a high quality oil-based finish of your choice. Nova offers our own finish, ExoShield[®]. Recommended maintenance cycle is once every 3 to 5 years for longest lasting color, UV protection and moisture protection!

For complete instructions on how to properly apply ExoShield[®], please visit:
<https://www.novausawood.com/exoshield>



IMPORTANT

You must contact your local building department before you begin designing your project. Your local building department (and/or Homeowner Association) will inform you of any zoning ordinances and buildings codes that specify where and how you can build. You are responsible for applying for and obtaining any and all required permits for your project.

Disclaimer:

Nova USA Wood Products provides this information as possible suggestions only and will not be held liable for your project's suitability or should you choose not to obtain the required permits, or if you fail to comply with all zoning ordinances and building codes.

By purchasing material from Nova USA Wood Products, you agree to comply with our Terms & Conditions. Our siding products are carefully manufactured and inspected to ensure quality. However, these are natural wood products and are subject to variations in weight, density, color, grain and performance. Wood siding is naturally subject to dimensional changes as the moisture content in the wood fluctuates with humidity in the air. Swelling, shrinkage, checking and other movement of individual pieces are normal occurrences in wood siding.

If you have any questions, contact us for written clarification prior to starting your project

Any Questions?



Please visit our FAQ page at

help.novausawood.com/Topic/ExoClad-QuickClips/4768120



Or call

(503) 419-6407